

May 31, 2015

Tokyo Electric Power Company Holdings, Inc.

# Air Dose Rates inside the Buildings

Sampling Period

Unit 6: from March 1, 2016 to March 31, 2016

---

Fukushima Daiichi NPS

Unit 6 Reactor Building 2nd Basement Floor

[mSv/h]

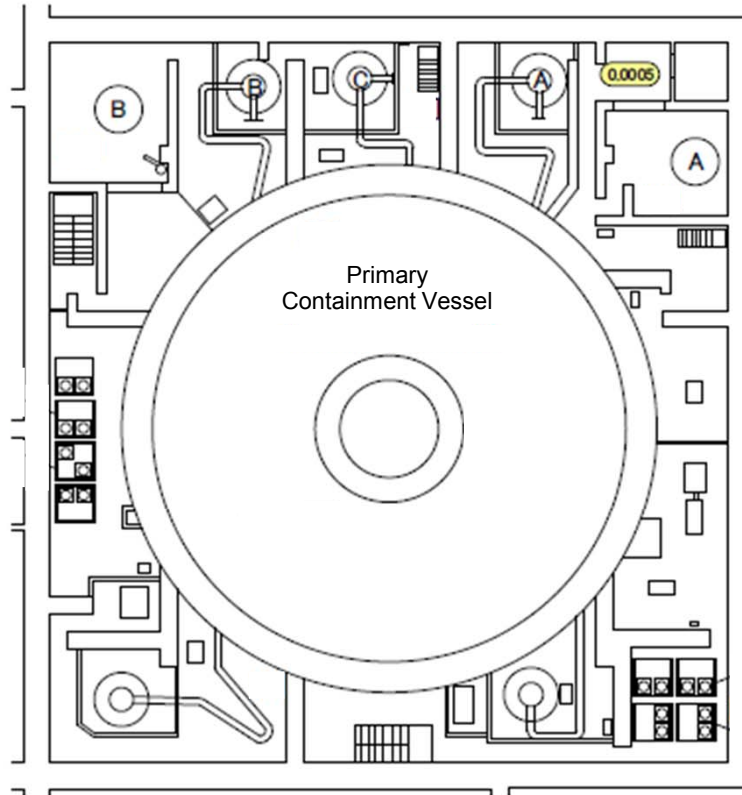
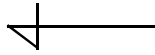

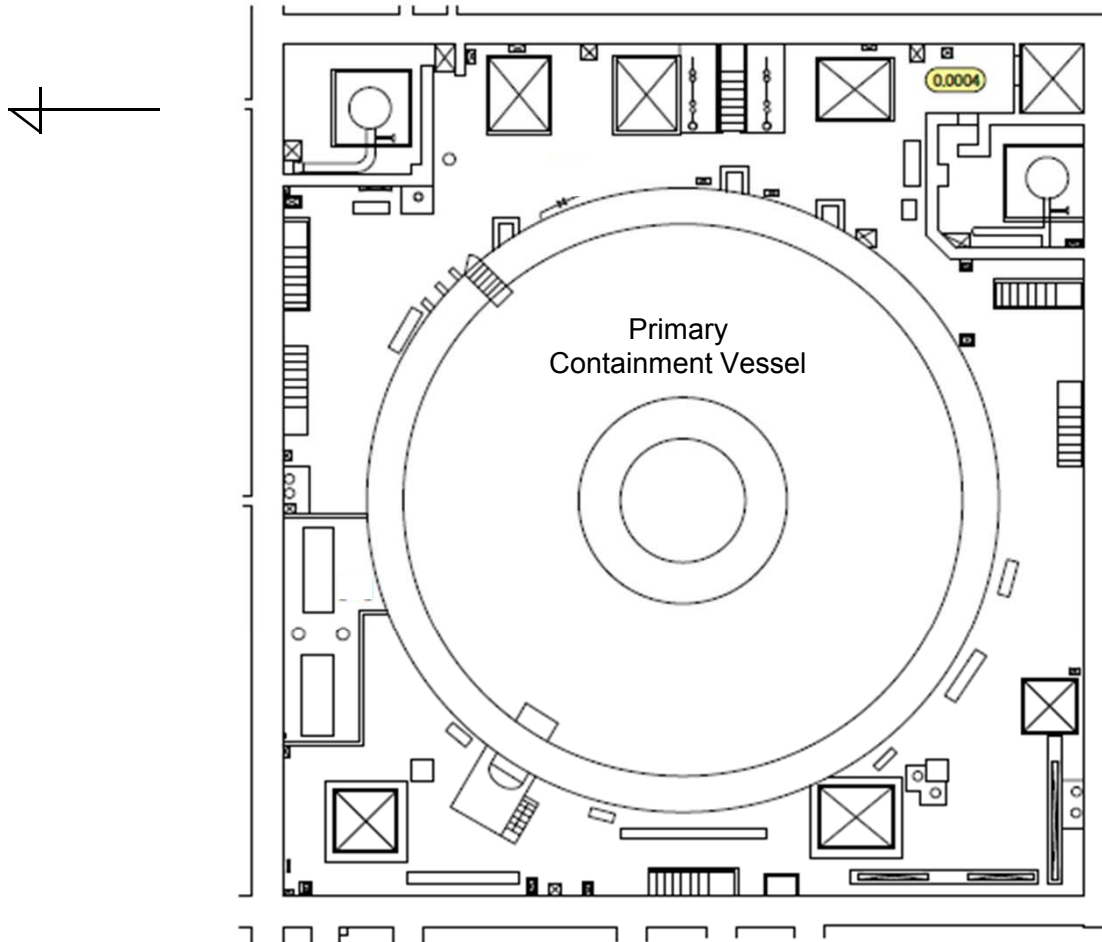

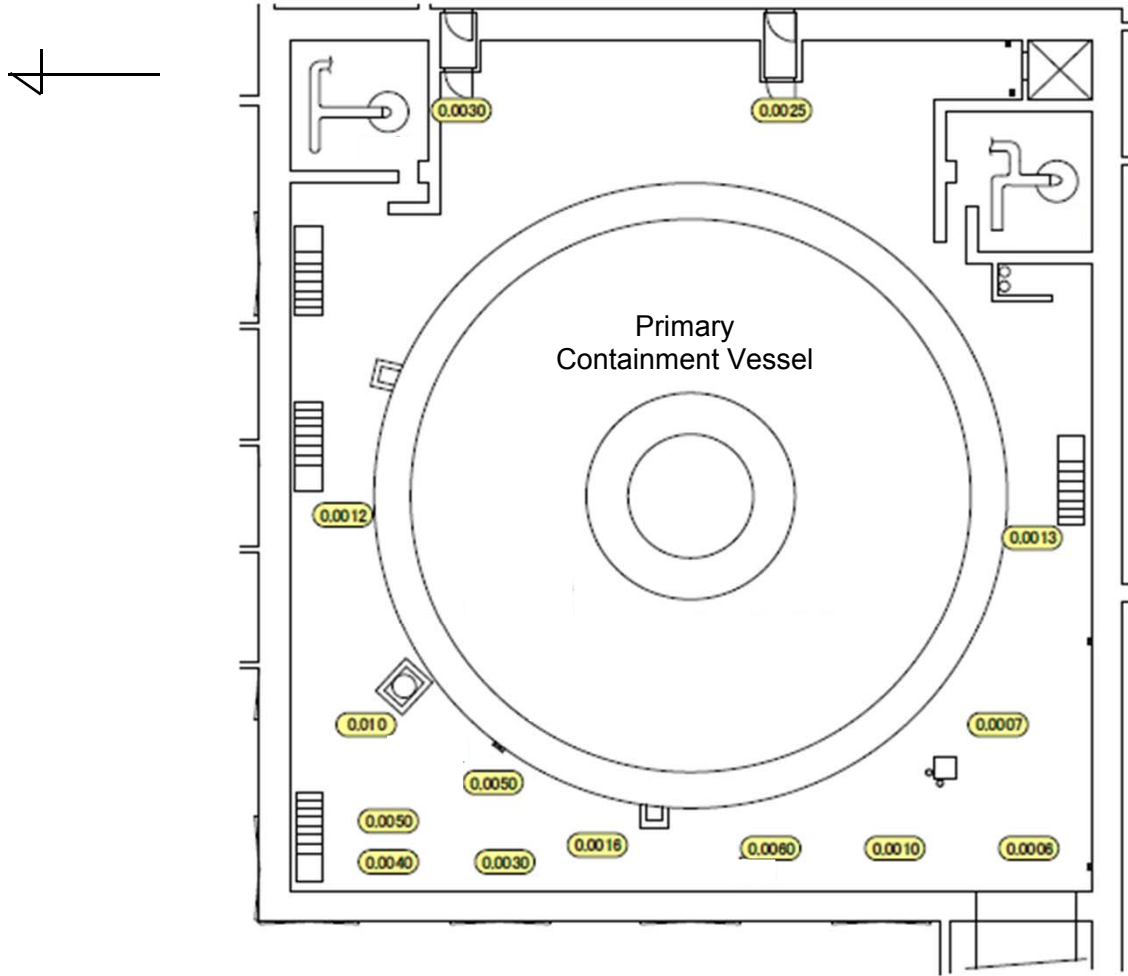

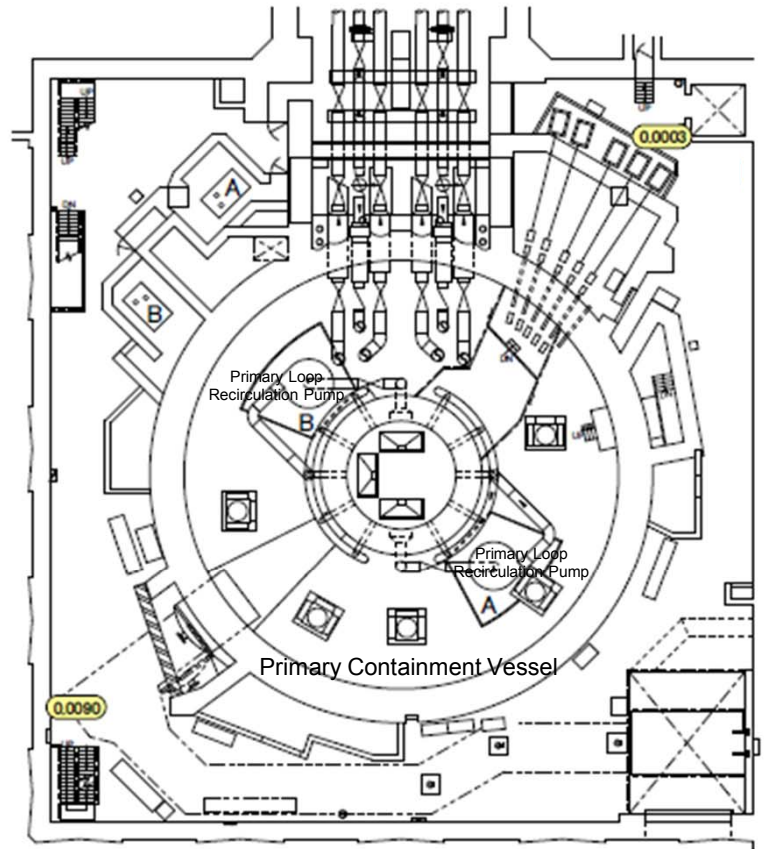
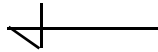

Fukushima Daiichi NPS

Unit 6 Reactor Building 3rd Floor

[mSv/h]

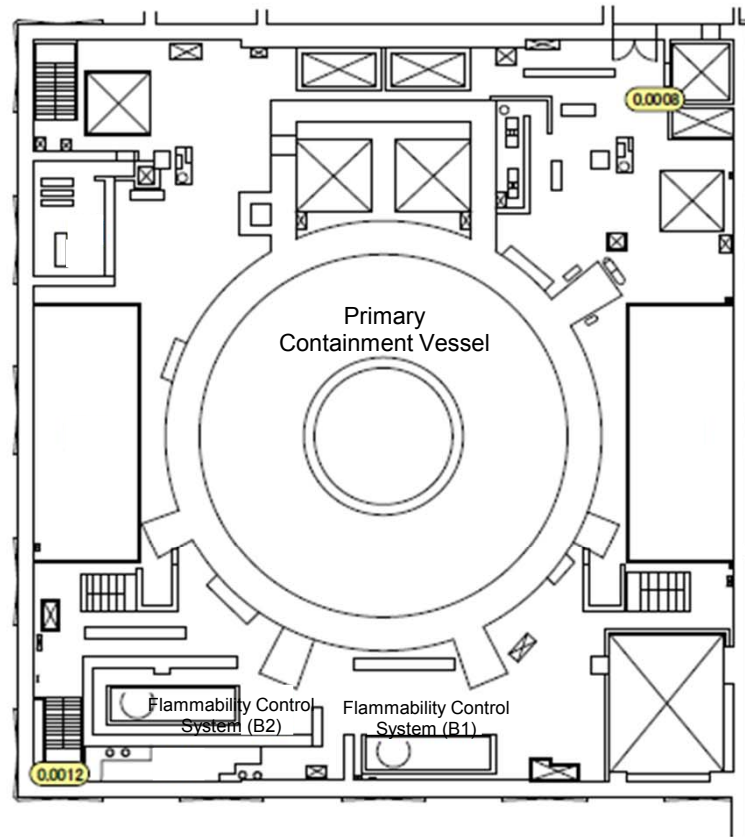
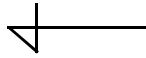

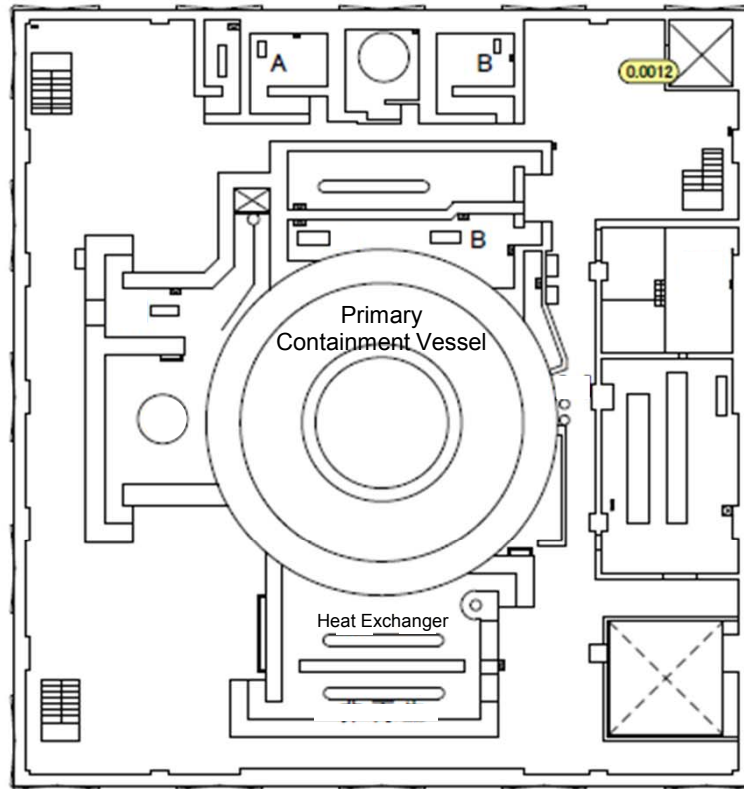
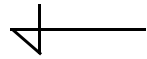

Fukushima Daiichi NPS	Unit 6 Reactor Building 5th Floor	[mSv/h]
-----------------------	-----------------------------------	---------

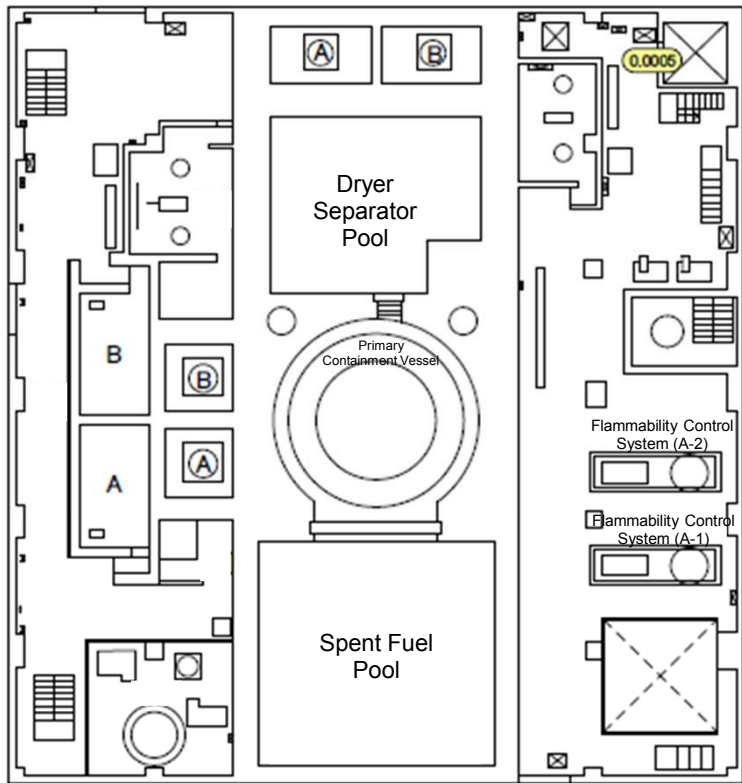
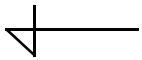



Fukushima Daiichi NPS

Unit 6 Reactor Building 6th Floor

[mSv/h]

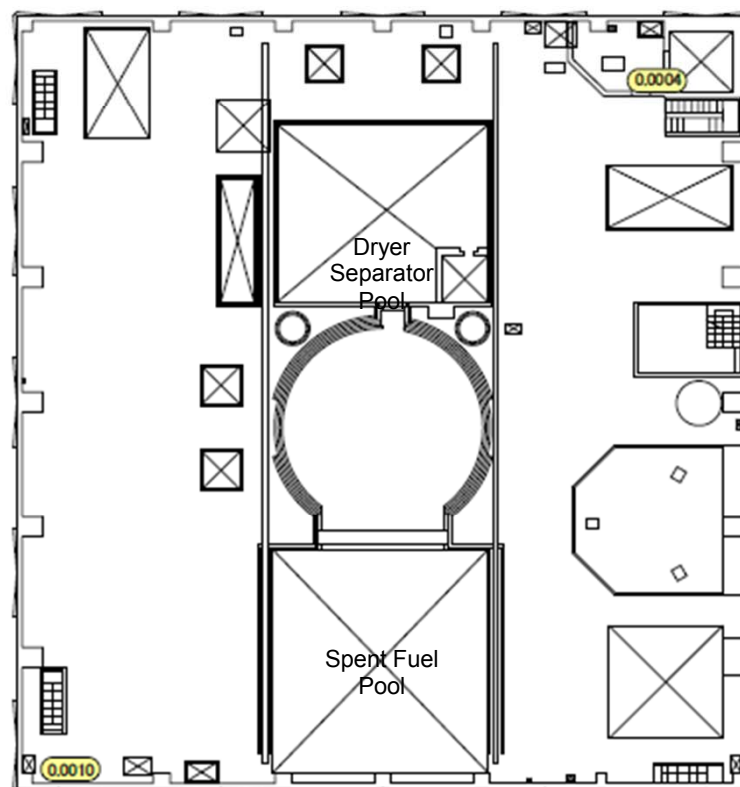
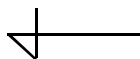

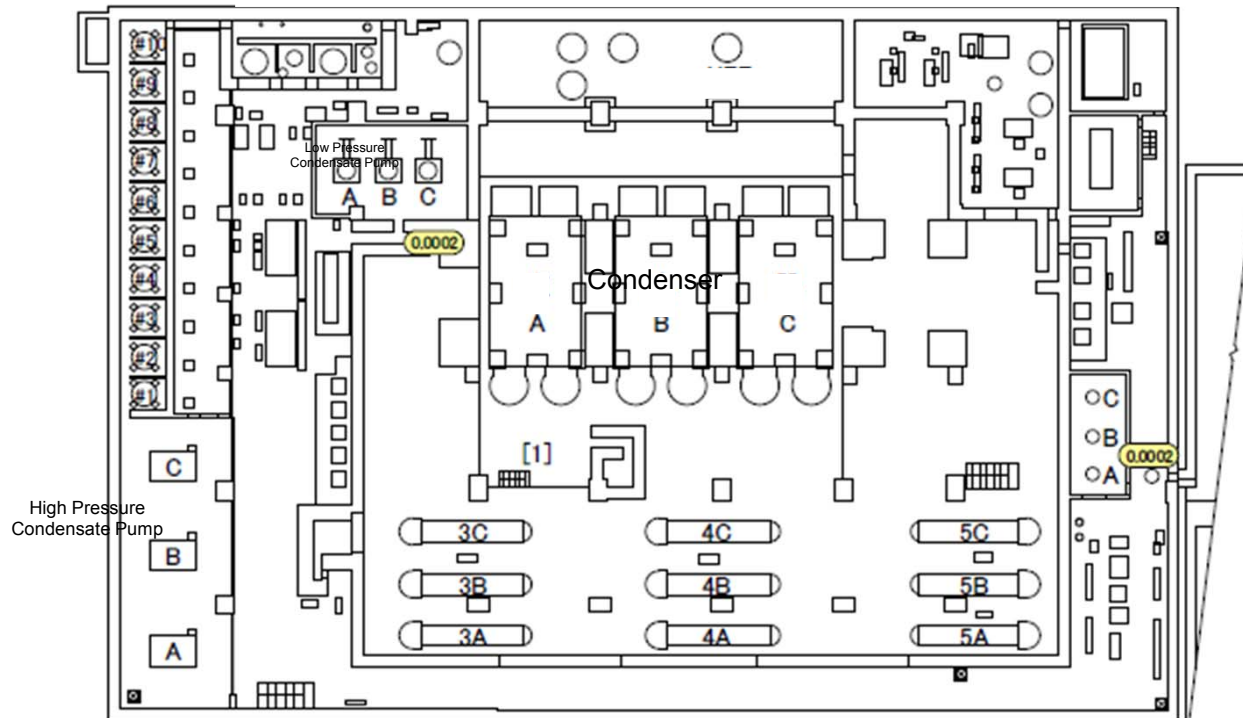
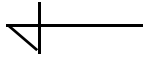

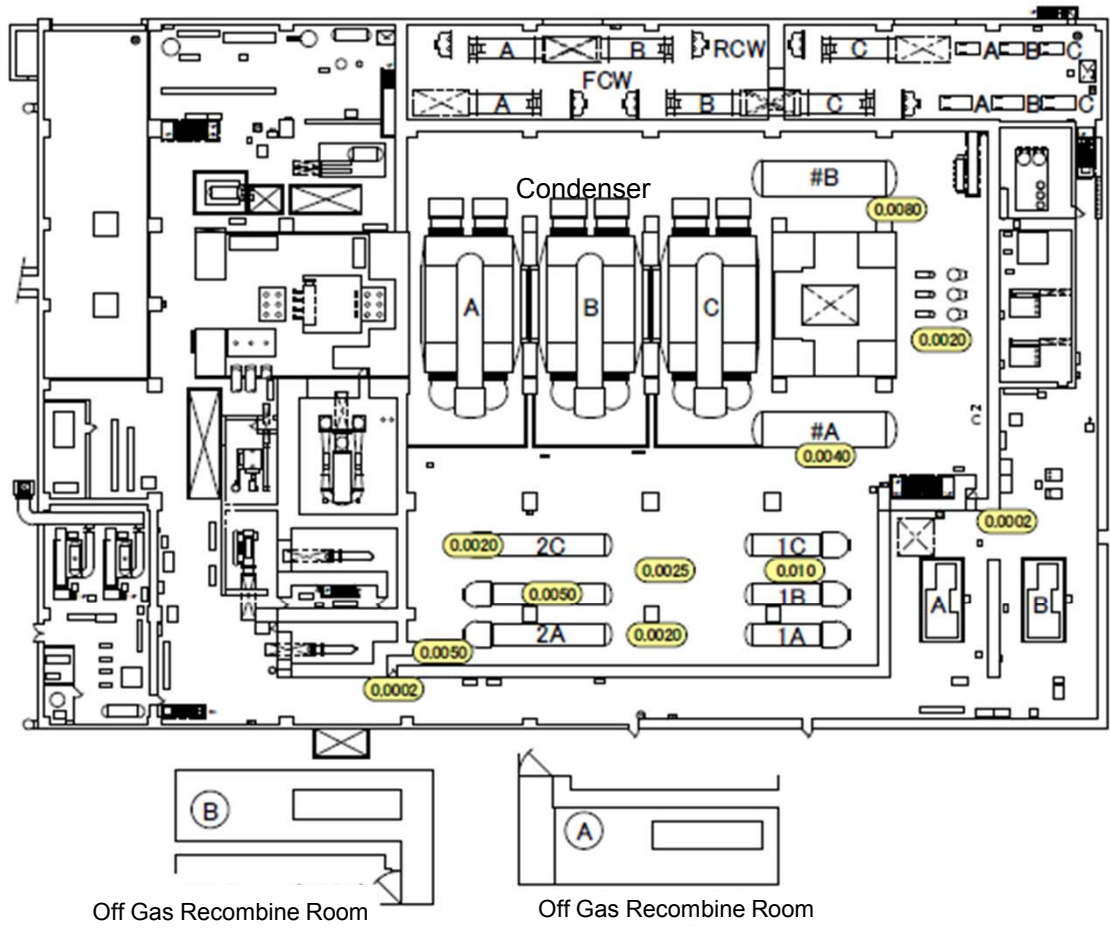
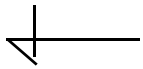

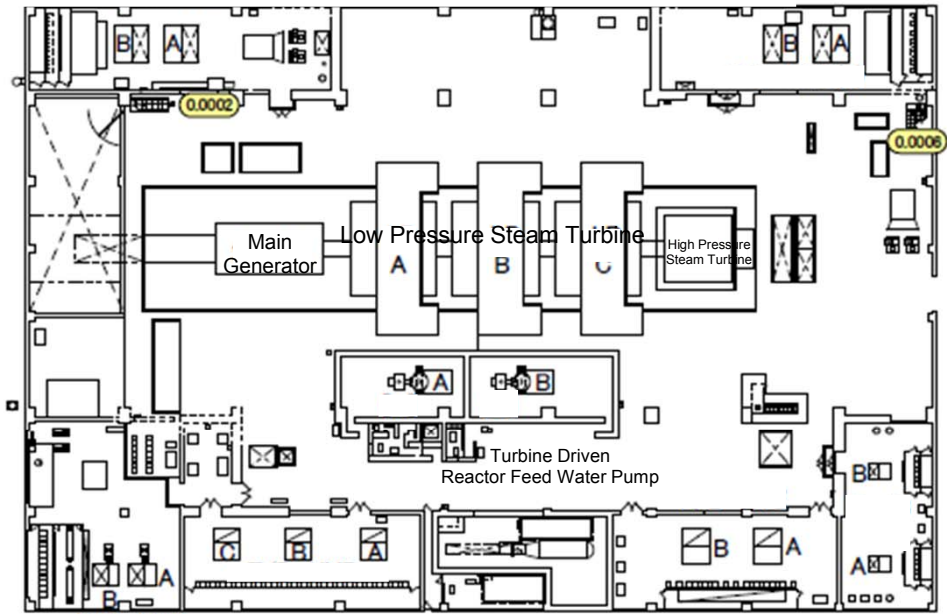
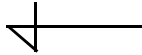

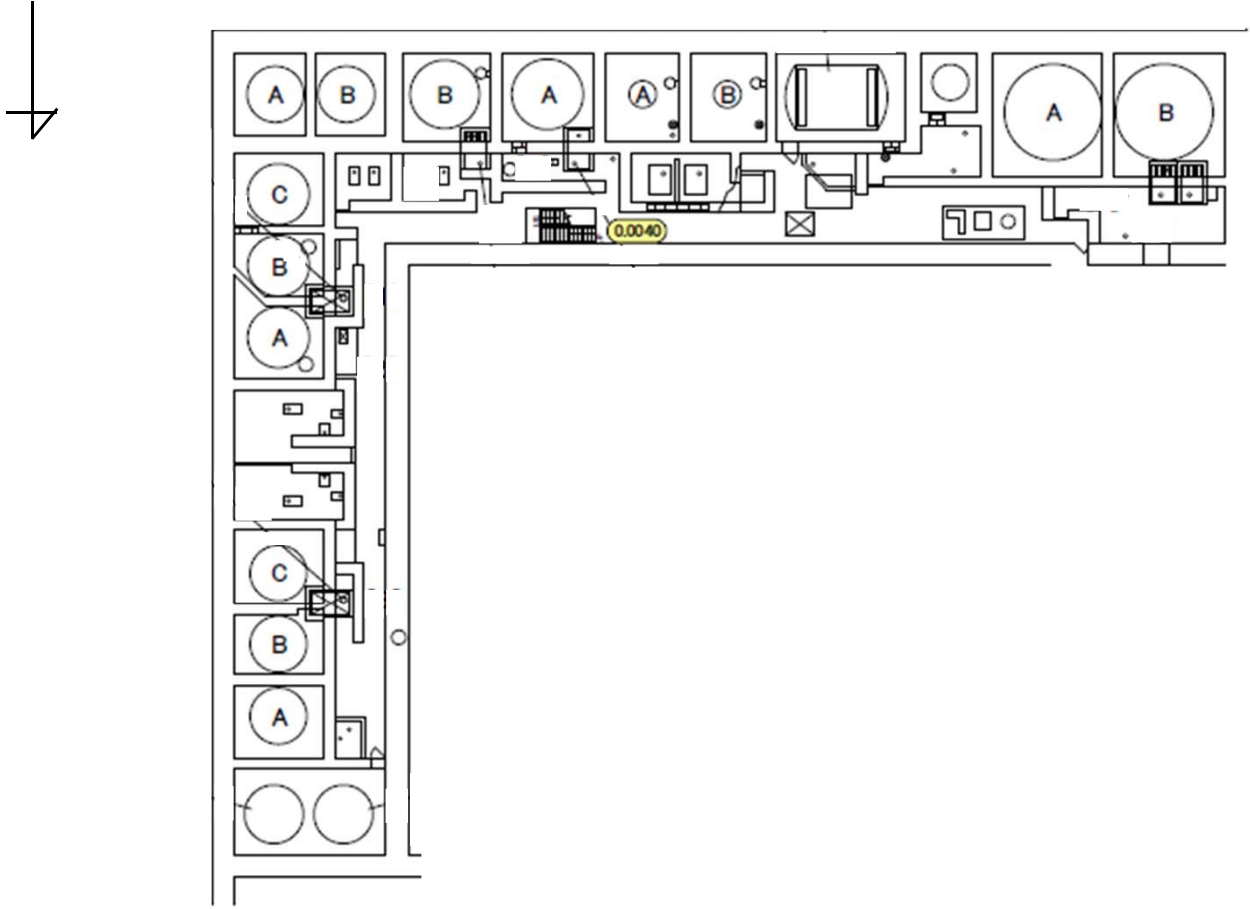

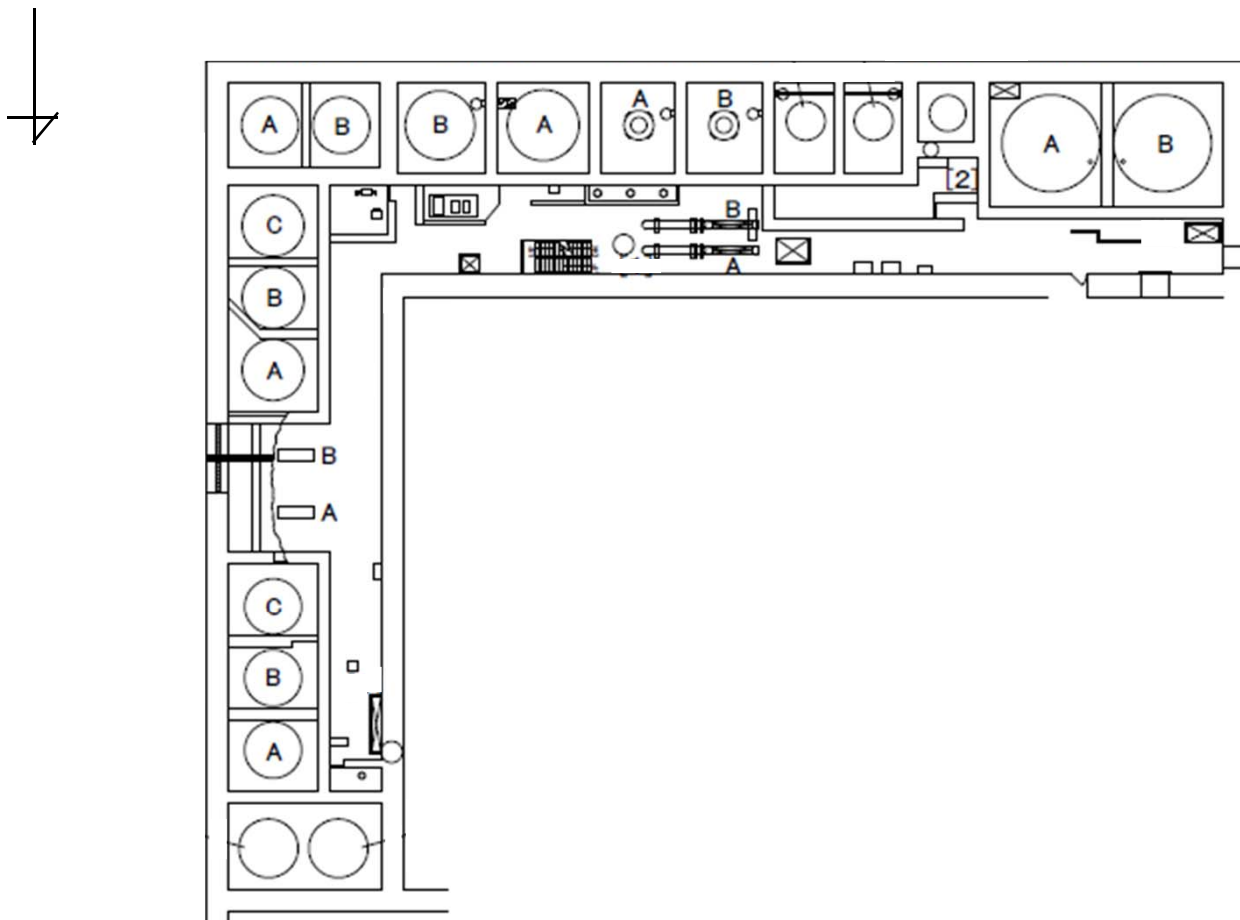

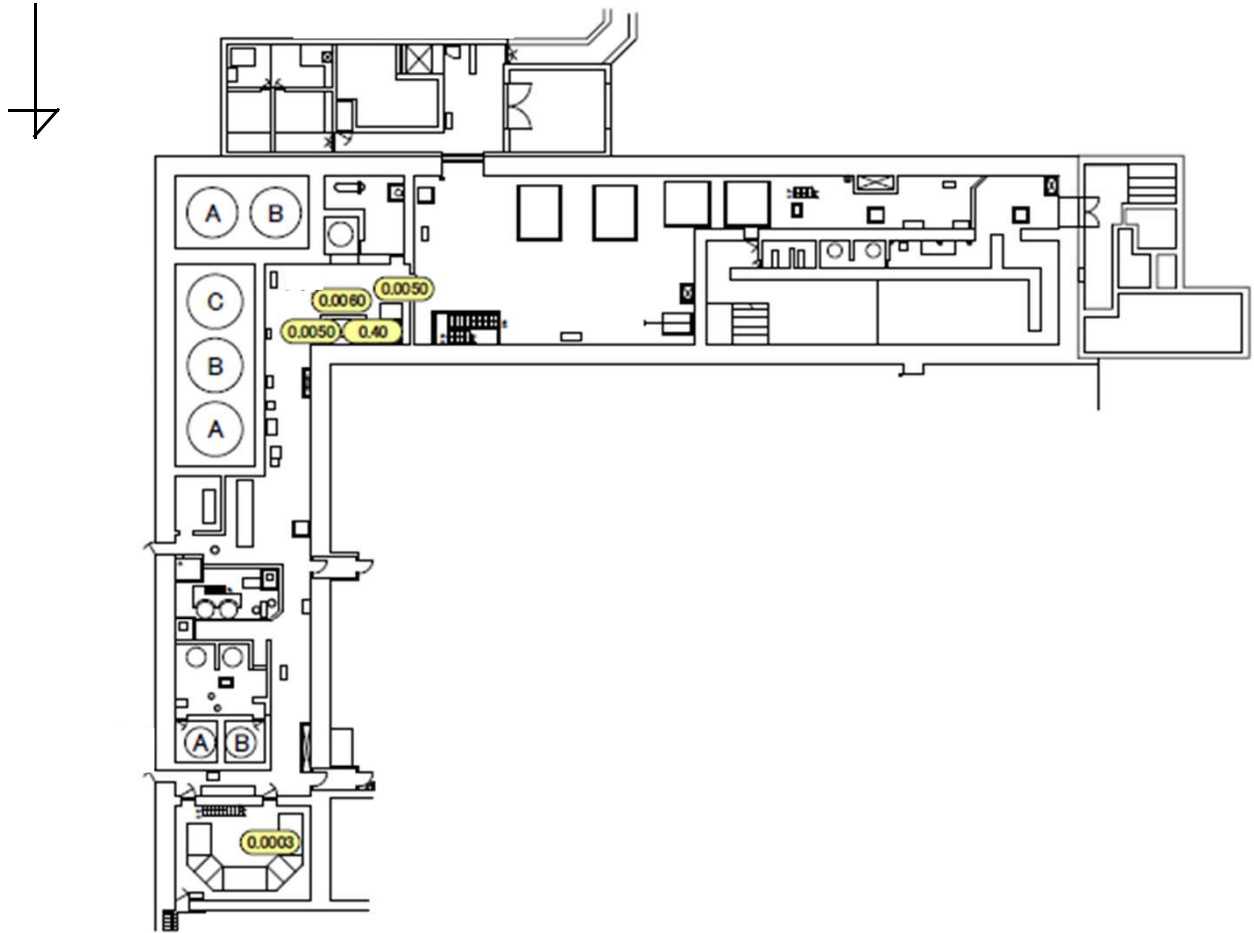

Fukushima Daiichi NPS	Unit 6 Radioactive Waste Treatment Facility Mezzanine Floor	[mSv/h]
-----------------------	---	---------

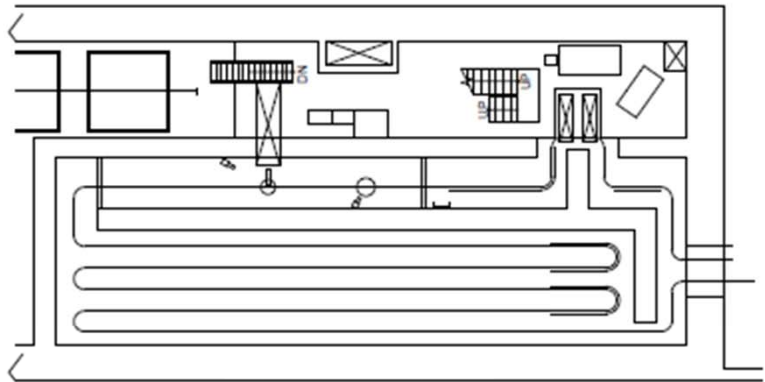



Fukushima Daiichi NPS

Unit 6 Radioactive Waste Treatment Facility 2nd Floor

[mSv/h]

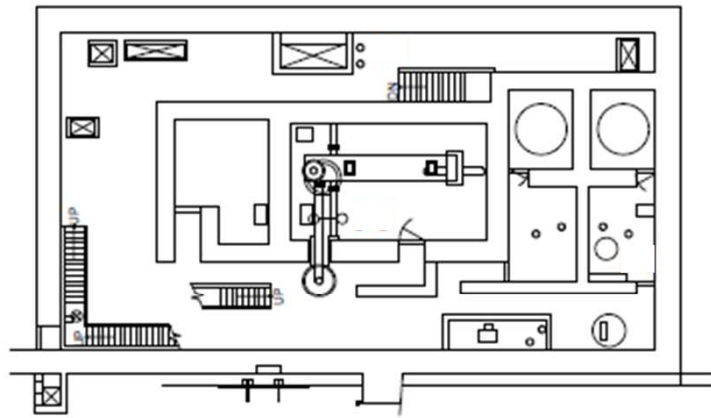

Fukushima Daiichi NPS

Unit 6 Radioactive Waste Treatment Facility 3rd Floor

[mSv/h]

